



GARDEN SPA

OUTDOOR SPA IN YOUR OWN GARDEN

We are delighted to introduce you our brand new Garden Spa category - a generation of Spa products, which brings a new level of innovation to our range. What could be more enjoyable than having an outdoor spa in your own garden, a relaxing area and a healthy extra space for yourself, your family and friends. With having a sauna in the garden you can easily transform your garden or property into a personal functional garden SPA.

We have in Garden Spa product range many saunas – let us introduce you the barrel saunas called Anita and an oval sauna Anette 3,0+1,5 m². There are five Anita barrel sauna models. The first, Anita 0,9 m²., is the smallest one, a very compact and little space requiring sauna. The larger Anitas are available with the wooden front wall and a glass front wall, accordingly Anita 1,3+0,7 m²., Anita 1,3+0,7 m². with glass wall, Anita 1,6+0,7 m². and Anita 1,6+0,7 m². with glass wall.

Electric heater can be ordered as an optional extra, there are HUUM Drop and Narvi NM heaters in our selection, please see the pages 185-186 for more information.

Please get familiar with the 3D cross-section showing the main features of an oval sauna Anette 3,0+1,5 m².

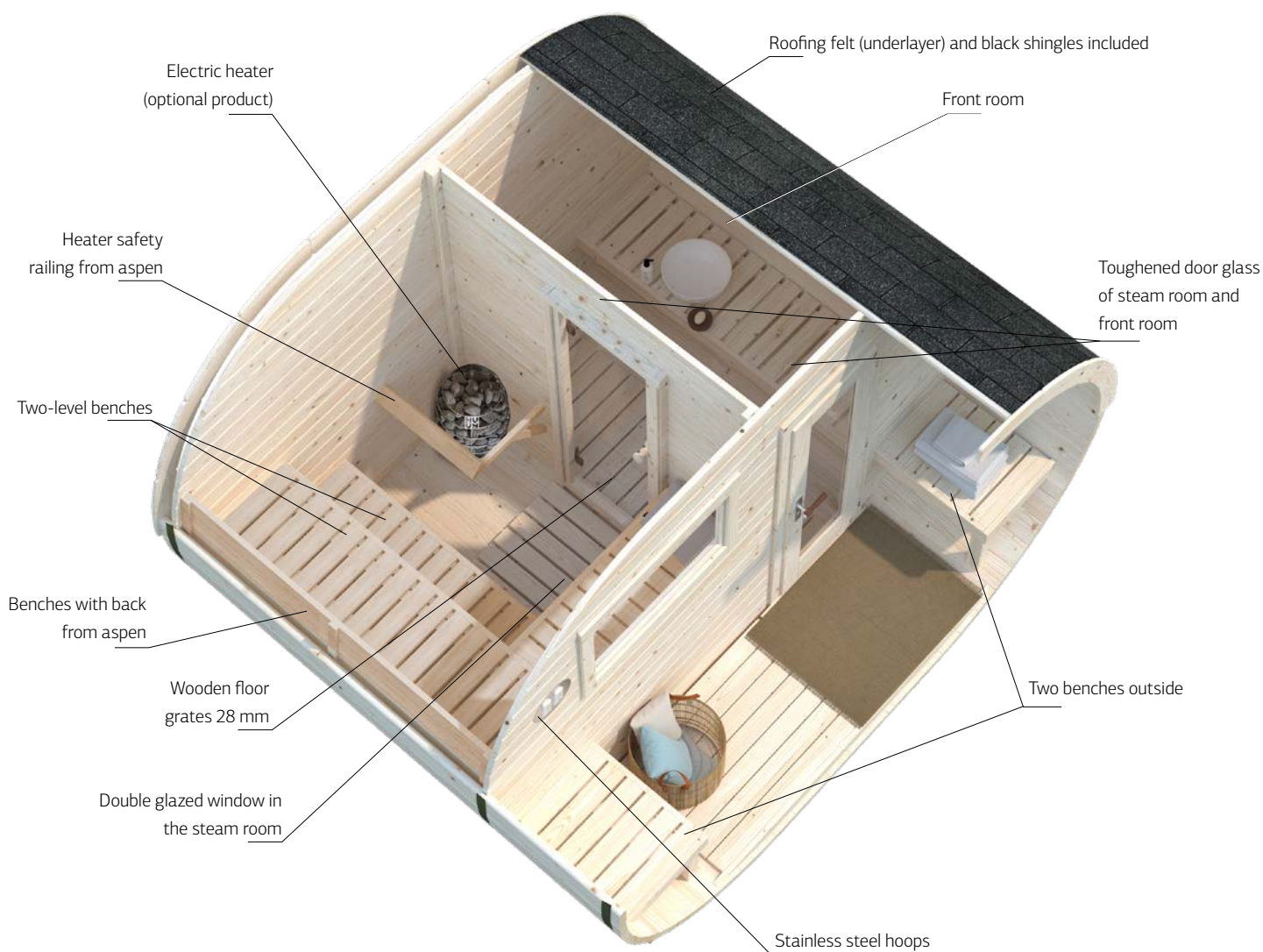



The shape of barrel and oval saunas provide a **good air circulation**, the heat distribution is very even because after hot air rises in the steam room it gently curls down each side of the sauna. Cool air is pulled in the low vent by the vacuum created by hot air rising, which then exhausts out the high vent on the opposite side of the room.

Steam room **benches with backside** take the pressure off from low back, shoulders and neck and help to ensure the spine in a neutral position. These benches are made of **aspen** which has low thermal conductivity and does not release resin.

The **two-level benches** (in Anita 0,9 m² and Anette 3,0+1,5 m²) allow each person to choose the optimal temperature regime.



Removable **28 mm wooden floor grates** can be easily cleaned, do not let to slip and feel really good under your bare feet.



Front room (in Anette 3,0+1,5 m²) can be used for many different purposes – you can either wash yourself or store the things there, change the clothes, take a short break or sometimes just hide from a bad weather.



Black shingles are included in the set. Shingles protect your sauna from the top and give the final touch in appearance. Anette 3,0+1,5 m² set includes additionally also the roofing felt (underlayer).



Both saunas have **high quality doors and window**. The glass door of the steam room has a 8 mm toughened glass, meanwhile the partly glazed outside door has a 4-6-4 mm double toughened glass. The window has a 3-6-3 mm double glass.

Window in the steam room (in Anette 3,0+1,5 m²) lets natural light inside the room and gives chance to look outside while taking bath procedures. Anita 1,3+0,7 m² glass wall and Anita 1,6+0,7 m² glass wall models have a glass front wall with 6 mm toughened glass, which lets you to enjoy the nice view to your garden.



The cozy benches outside offer a nice place where to take a short break, breathe the fresh air or enjoy some refreshments.



PALMAKO SAUNA
ANITA 0,9 m²



PALMAKO SAUNA
ANITA 1,3+0,7 m²



PALMAKO SAUNA
ANITA 1,3+0,7 m² WITH GLASS WALL



PALMAKO SAUNA
ANITA 1,6+0,7 m²



PALMAKO SAUNA
ANITA 1,6+0,7 m² WITH GLASS WALL



PALMAKO SAUNA
ANETTE 3,0+1,5 m²



PALMAKO SAUNA
SANNA 4,1 m²



PALMAKO SAUNA
SANNA 4,1+5,9 m²



PALMAKO SAUNA
SANNA 6,8 m²



PALMAKO SAUNA
SANNA 6,8+5,9 m²



PALMAKO SAUNA
SANNA 12,8 m² SLIDE



PALMAKO SAUNA
SANNA 12,8 m² SLIDE PLUS

PALMAKO SAUNA ANITA 0,9 m²

ARTICLE NUMBER: 110343

under
2,5m

NEW!

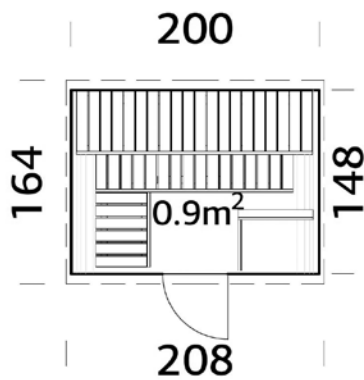

MODEL SPECIFICATIONS

Diameter 200 cm**Length:** 160 cm**Width:** 200 cm**Vertical walls:** 28 mm**Steam room measurements:**

191x142 cm

Volume: 4,1 m³**Door/window type:** Summer**Steam room door glass:**

Toughened, 8 mm

Door opening measurements:

50x161 cm

Roof area: 5,0 m²**Capacity:** 3 people**Inside measures of heater
safety railing:** 634x457 mm

Shingles included.

Steam room benches and heater safety railing from aspen.

Two-level steam room benches with backside..

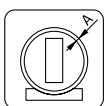

42 mm

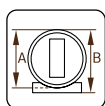
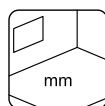
**A:** 200 cm
B: 206 cm**Floor grates**
28 mm

OPTIONAL

Roofing felt (underlayer): 1 roll, SBS roofing material: 1 roll, roofing nails, additional door. See Optional Products p. 324-345 for details.

PALMAKO SAUNA ANITA 1,3+0,7 m²

ARTICLE NUMBER: 110070

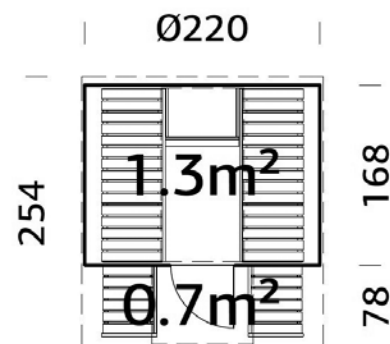
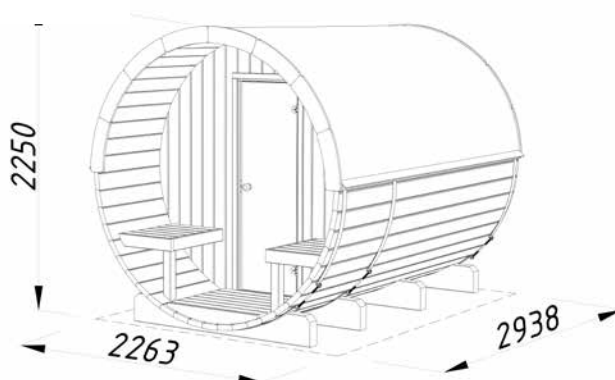
under
2,5m**MODEL SPECIFICATIONS****Diameter:** 220 cm**Length:** 250 cm**Width:** 220 cm**Vertical walls:** 28 mm**Steam room measurements:**

211x162 cm

Volume: 8,4 m³**Door/window type:** Summer**Steam room door glass:**

Toughened, 8 mm

Door opening measurements:

50x161 cm

Roof area: 8,6 m²**Roof overhang:** 78 cm**Capacity:** 4 people**Inside measures of heater****safety railing:** 634x457 mm

Shingles included.

Steam room benches and heater safety railing from aspen.

Sitting benches outside.

NB! Heater is an optional extra!

OPTIONAL

HUUM Drop electric heater (stones and remote control included), Narvi NM electric heater (stones included), roofing felt (underlayer) 2 rolls, SBS roofing material: 2 rolls, roofing nails, additional door. See Optional Products p. 324-345 for details.

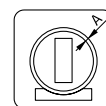

42 mm

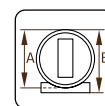
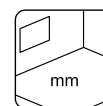
A: 220 cm
B: 225 cm

Floor grates
28 mm

PALMAKO SAUNA ANITA 1,3+0,7 m²

ARTICLE NUMBER: 111005

WITH GLASS WALL

under
2,5m

NEW!

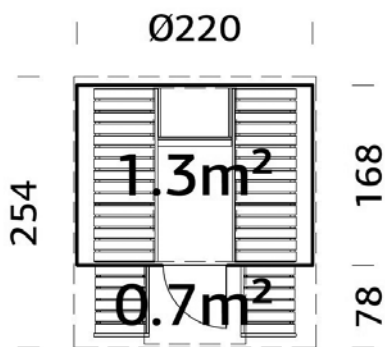

MODEL SPECIFICATIONS

Diameter: 220 cm**Length:** 250 cm**Width:** 220 cm**Vertical walls:** 28 mm**Steam room measurements:**

211x162 cm

Volume: 8,4 m³**Door/window type:** Summer**Steam room door glass:**

Toughened, 8 mm

Front wall glass:

Toughened, 6 mm

Door opening measurements:

50x161 cm

Roof area: 8,6 m²**Roof overhang:** 78 cm**Capacity:** 4 people**Inside measures of heater safety****railing:** 634x457 mm

Shingles included.

Steam room benches and heater

safety railing from aspen.

Glass front wall.

Sitting benches outside.

NB! Heater is an optional extra!

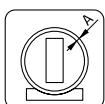

42 mm

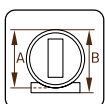
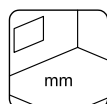
**A:** 220 cm
B: 225 cm**Floor grates**
28 mm

OPTIONAL

HUUM Drop electric heater (stones and remote control included), Narvi NM electric heater (stones included), roofing felt (underlayer) 2 rolls, SBS roofing material: 2 rolls, roofing nails, additional door. See Optional Products p. 324-345 for details.

PALMAKO SAUNA ANITA 1,6+0,7 m²

ARTICLE NUMBER: 111003

under
2,5m

NEW!

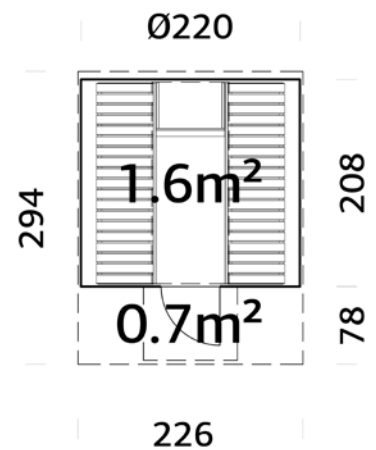
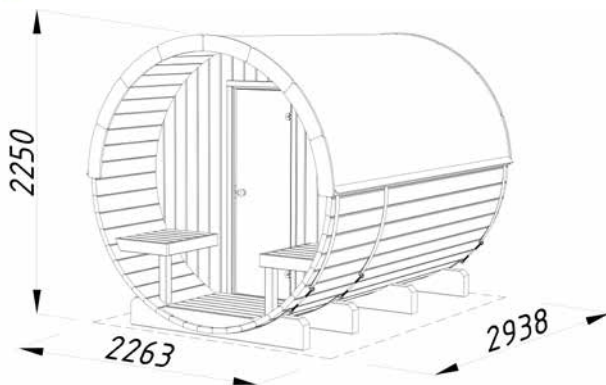

MODEL SPECIFICATIONS

Diameter: 220 cm
Length: 290 cm
Width: 220 cm
Vertical walls: 28 mm
Steam room measurements: 211x202 cm
Volume: 9,8 m³
Door/window type: Summer
Steam room door glass: Toughened, 8 mm

Front wall glass: Toughened, 6 mm
Door opening measurements: 50x161 cm
Roof area: 10,4 m²
Roof overhang: 78 cm
Capacity: 6 people
Inside measures of heater safety railing: 634x457 mm

Shingles included.
 Steam room benches and heater safety railing from aspen.
 Sitting benches outside.
 NB! Heater is an optional extra!

OPTIONAL

HUUM Drop electric heater (stones and remote control included), Narvi NM electric heater (stones included), roofing felt (underlayer): 2 rolls, SBS roofing material: 2 rolls, roofing nails, additional door. See Optional Products p. 324-345 for details.

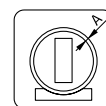

42 mm

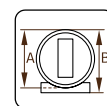

A: 220 cm
 B: 225 cm

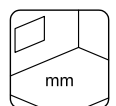

Floor grates
 28 mm

PALMAKO SAUNA ANITA 1,6+0,7 m²

ARTICLE NUMBER: 111004 WITH GLASS WALL

under
2,5m

NEW!

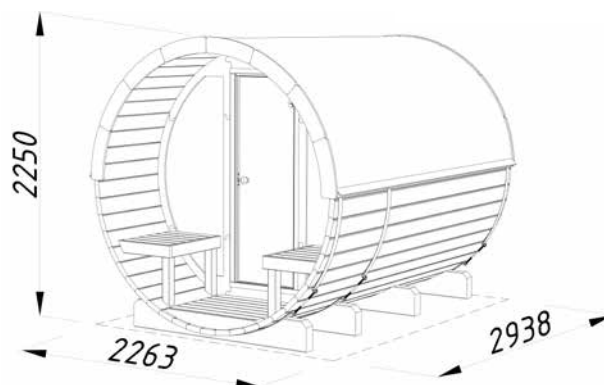
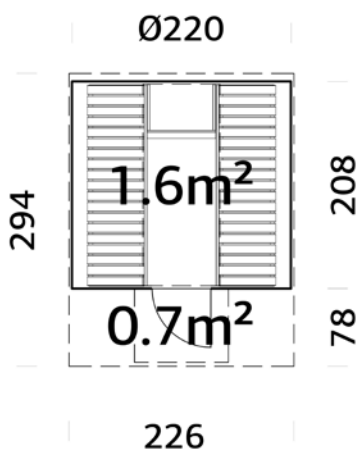

MODEL SPECIFICATIONS

Diameter: 220 cm

Length: 290 cm

Width: 220 cm

Vertical walls: 28 mm

Steam room measurements:

211x202 cm

Volume: 9,8 m³

Door/window type: Summer

Steam room door glass:

Toughened, 8 mm

Front wall glass: Toughened, 6 mm

Door opening measurements:

50x161 cm

Roof area: 10,4 m²

Roof overhang: 78 cm

Capacity: 6 people

Inside measures of heater safety

railing: 634x457 mm

Shingles included.

Steam room benches and heater safety railing from aspen.

Glass front wall.

Sitting benches outside.

NB! Heater is an optional extra!

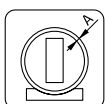

42 mm

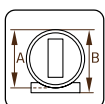

A: 220 cm
B: 225 cm

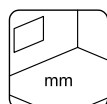

Floor grates
28 mm

OPTIONAL

HUUM Drop electric heater (stones and remote control included), Narvi NM electric heater (stones included), roofing felt (underlayer): 2 rolls, SBS roofing material: 2 rolls, roofing nails, additional door. See Optional Products p. 324-345 for details.

PALMAKO SAUNA ANETTE 3,0+1,5 m²

ARTICLE NUMBER: 110071

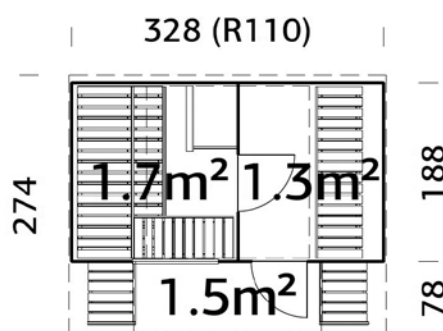
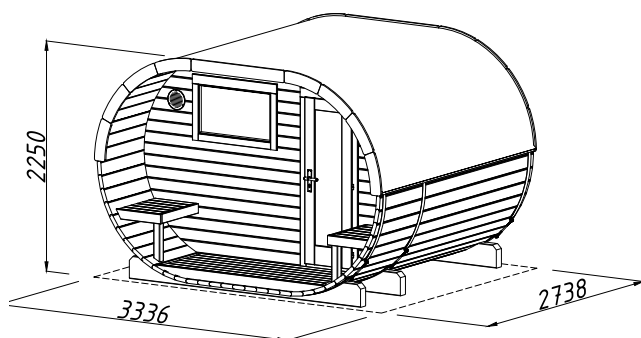
under
2,5m**MODEL SPECIFICATIONS****Length:** 270 cm**Width:** 328 cm**Vertical walls:** 28 mm**Steam room measurements:**

169x182 cm

Front room measurements:

147x182 cm

Volume: 15,0 m³**Door/window type:** Garden+**Steam room door glass:**

Toughened, 8 mm

Front room door glass:

Toughened, 4-6-4 mm

Window glass:

Double glass, 3-6-3 mm

Door opening measurements:

49x159, 50x161 cm

Fixed window measurements:

80x45 cm

Roof area: 12,1 m²**Roof overhang:** 78 cm**Capacity:** 4 people**Inside measures of heater****safety railing:** 634x457 mm

334

Roofing felt (underlayer) and shingles included.

Steam room benches and heater safety railing from aspen.

Two-level steam room benches with backside.

Front room.

Window in the steam room.

Sitting benches outside.

NB! Heater is an optional extra!

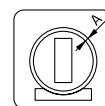

42 mm

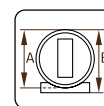
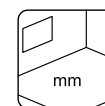
A: 220 cm
B: 225 cmFloor grates
28 mm**OPTIONAL**

HUUM Drop electric heater (stones and remote control included), Narvi NM electric heater (stones included), SBS roofing material: 2 rolls, roofing nails, additional door and window. See Optional Products p. 324-345 for details.

PALMAKO LOG SAUNAS

Garden Spa product range includes different looking saunas, everyone should find a sauna they are looking for. In addition to the barrel and oval saunas one can relax and enjoy the sauna rituals also in our log saunas called Sanna.



Sanna steam room ceilings are provided with the 30 mm **insulation** and covered with the 16 mm **wooden cladding**.



Steam room benches are made of **aspen** which has low thermal conductivity and does not release resin. The **two-level benches** allow each person to choose the optimal temperature regime.



The **cozy sitting bench** outside offer a nice place where to cool down after the session in steam room and take a short break meanwhile the **Louvre panel** provides privacy.



Sanna saunas have **high quality doors and windows**. The glass door of the steam room has a 8 mm toughened glass, meanwhile the partly glazed outside door has a 4-9-4 mm double toughened glass. All windows have a 4-9-4 double toughened glass. All Sanna saunas have **window in the steam room and front room**, which lets natural light inside the room and lets enjoy the view from inside out.



The frame colour of Sanna 12,8 m² **sliding doors** is dark grey RAL7016. Sliding door Slide has 4 mm toughened glass, sliding door Slide Plus 4-16-4 mm double toughened glass.



PALMAKO SAUNA SANNA 4,1 m²

ARTICLE NUMBER: 110741

under
2,5m

NEW!



Can be built in reverse!

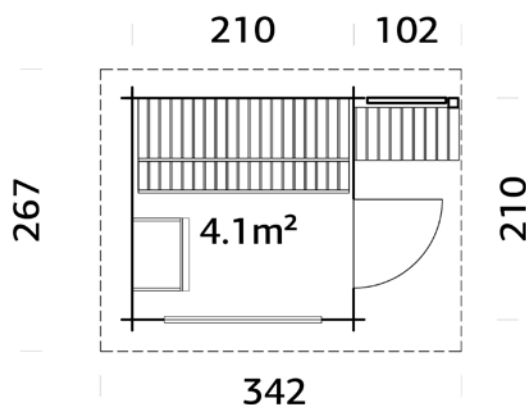

MODEL SPECIFICATIONS

Log measurements: 230+102x230 cm**Steam room measurements:** 201x201 cm**Volume:** 9,2 m³**Door/window type:** Summer**Door/window glass:**

Toughened, 4-9-4 mm

Fixed window measurements: 132x81 cm**Door opening measurements:** 67x183 cm**Steam room ceiling insulation:** 30 mm**Steam room ceiling boards:** 16 mm**Door sill:** low, covered with stainless steel**Roof boards:** 19 mm**Roof area:** 8,9 m²**Roof gradient:** 6,3°**Capacity:** 3 people**Gross ground area:** 4,4 m²**Inside measures of heater safety railing:**

634x457 mm

Steam room benches and heater safety railing from aspen.

Two-level steam room benches with backside.

Window in the steam room.

Sitting bench outside under the roof overhang.

Louvre panel outside for more privacy.

NB! Heater is an optional extra!

OPTIONAL

HUUM Drop electric heater (stones and remote control included), Narvi NM electric heater (stones included), roofing felt (underlayer): 2 rolls, SBS roofing material: 2 rolls, roofing nails, EPDM, rain gutters, additional door and window. See Optional Products p. 324-345 for details.

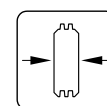

44 mm

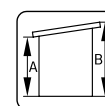
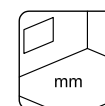
A: 217 cm
B: 245 cmIncluded
28 mm

PALMAKO SAUNA SANNA 4,1+5,9 m²

ARTICLE NUMBER: 111001

under
2,5m

NEW!

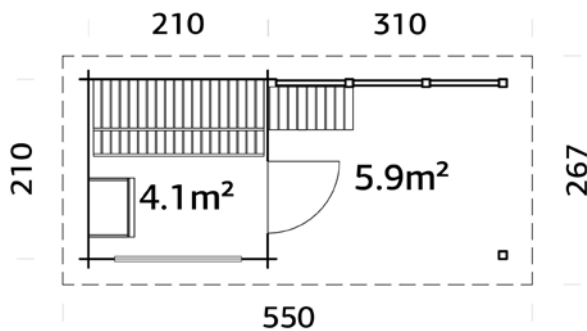

Can be built in reverse!

Steam room benches and heater safety railing from aspen.

Two-level steam room benches with backside.

Window in the steam room.

Sitting bench outside under the roof overhang.

Louvre panel outside for more privacy.

NB! Heater is an optional extra!

MODEL SPECIFICATIONS

Log measurements: 230+310x230 cm

Steam room measurements: 201x201 cm

Volume: 9,2+13,4 m³

Door/window type: Summer

Door/window glass:

Toughened, 4-9-4 mm

Fixed window measurements: 132x81 cm

Door opening measurements: 67x183 cm

Steam room ceiling insulation: 30 mm

Steam room ceiling boards: 16 mm

Door sill: low, covered with stainless steel

Roof boards: 19 mm

Roof area: 14,4 m²

Roof gradient: 6,3°

Capacity: 3 people

Gross ground area: 10,5 m²

Inside measures of heater safety railing: 634x457 mm

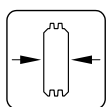

44 mm

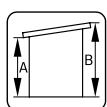

A: 217 cm
B: 245 cm

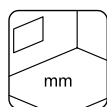

Included
28 mm

OPTIONAL

HUUM Drop electric heater (stones and remote control included), Narvi NM electric heater (stones included), roofing felt (underlayer): 4 rolls, SBS roofing material: 4 rolls, roofing nails, EPDM, rain gutters, additional door and window. See Optional Products p. 324-345 for details.

PALMAKO SAUNA SANNA 6,8 m²

ARTICLE NUMBER: 110526

under
2,5m

NEW!



Can be built in reverse!

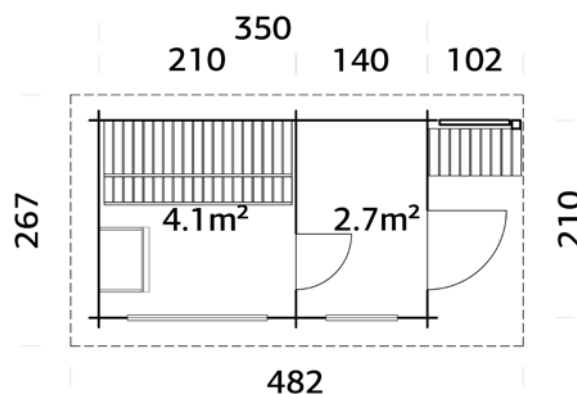

MODEL SPECIFICATIONS

Log measurements: 370+102x230 cm**Front room measurements:** 201x135 cm**Steam room measurements:**
201x201 cm**Steam room door glass:**
Toughened, 8 mm**Volume:** 15,7 m³**Door/window type:** Summer**Door/window glass:**
Toughened, 4-9-4 mm**Fixed window measurements:**

60x149 cm, 132x81 cm

Door opening measurements:

67x183 cm, 59x179 cm

Steam room ceiling insulation: 30 mm**Steam room ceiling boards:** 16 mm**Door sill:** low, covered with stainless steel**Roof boards:** 19 mm**Roof area:** 12,6 m²**Roof gradient:** 6,3°**Capacity:** 3 people**Gross ground area:** 7,4 m²**Inside measures of heater safety railing:**

634x457 mm

Steam room benches and heater safety railing from aspen.

Two-level steam room benches with backside.

Front room.

Window in the steam room.

Sitting bench outside under the roof overhang.

Louvre panel outside for more privacy.

NB! Heater is an optional extra!

OPTIONAL

HUUM Drop electric heater (stones and remote control included), Narvi NM electric heater (stones included), roofing felt (underlayer): 2 rolls, SBS roofing material: 2 rolls, roofing nails, EPDM, rain gutters, additional door and window. See Optional Products p. 324-345 for details.

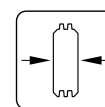

44 mm

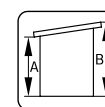
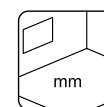
A: 217 cm
B: 245 cmIncluded
28 mm

PALMAKO SAUNA SANNA 6,8+5,9 m²

ARTICLE NUMBER: 111002

under
2,5m

NEW!

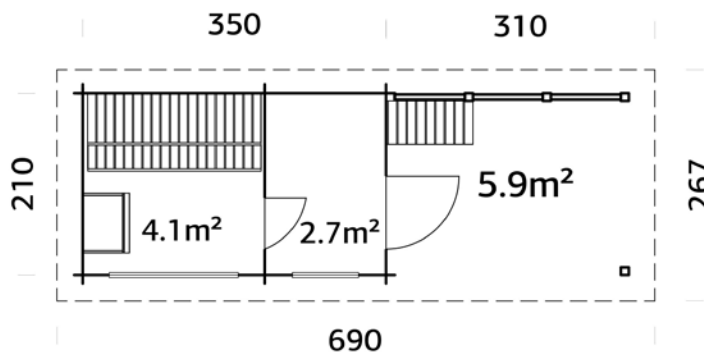

Can be built in reverse!

Steam room benches and heater safety railing from aspen.

Two-level steam room benches with backside.

Front room.

Window in the steam room.

Sitting bench outside under the roof overhang.

Louvre panel outside for more privacy.

NB! Heater is an optional extra!

MODEL SPECIFICATIONS

Log measurements: 370+310x230

Front room measurements: 201x135 cm

Steam room measurements: 201x201 cm

Steam room door glass:

Toughened, 8 mm

Volume: 15,7+13,4 m³

Door/window type: Summer

Door/window glass:

Toughened, 4-9-4 mm

Fixed window measurements:

60x149 cm, 132x81 cm

Door opening measurements:

67x183 cm, 59x179 cm

Steam room ceiling insulation: 30 mm

Steam room ceiling boards: 16 mm

Door sill: low, covered with stainless steel

Roof boards: 19 mm

Roof area: 18,4 m²

Roof gradient: 6,3°

Capacity: 3 people

Gross ground area: 13,5 m²

Inside measures of heater safety railing:

634x457 mm

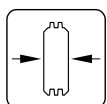

44 mm

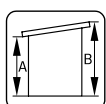

A: 217 cm
B: 245 cm

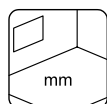

Included
28 mm

OPTIONAL

HUUM Drop electric heater (stones and remote control included), Narvi NM electric heater (stones included), roofing felt (underlayer): 4 rolls, SBS roofing material: 4 rolls, roofing nails, EPDM, rain gutters, additional door and window. See Optional Products p. 324-345 for details.

PALMAKO SAUNA SANNA 12,8 m² SLIDE

under
2,5m

NEW!

ARTICLE NUMBER: 111000

168-187



Can be built in reverse!

PALMAKO SAUNA SANNA 12,8 m² SLIDE PLUS

Article number: 111239

NEW!



Slide
Single glass, toughened, 4 mm



Slide Plus
Double glass, toughened, 4-16-4 mm

Please read more about sliding doors on pages 340-341.
Sliding door frame colour: RAL7016

MODEL SPECIFICATIONS

Log measurements 520x290 cm

Steam room measurements:
261x143cm

Front room measurements:
343x261 cm

Volume: 28,6 m³

Steam room door glass:
Toughened, 8 mm

Fixed window opening measurements: 60x149 cm

Door opening measurements:
59x179 cm

Sliding door opening measurements (three sheets)
176x187 cm (Slide), 172x185 cm (Slide Plus)

Steam room ceiling insulation:
30 mm

Steam room ceiling boards:
16 mm

Door sill: low, covered with stainless steel

Roof boards: 19 mm

Roof area: 18,3 m²

Roof gradient: 4,9°

Capacity: 3 people

Gross ground area: 13,5 m²

Inside measures of heater safety railing: 634x457 mm

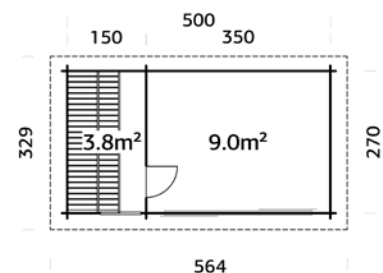

Sliding doors included.

Steam room benches and heater safety railing from aspen.

Two-level steam room benches with backside.

Front room.

Window in the steam room.

NB! Heater is an optional extra!

OPTIONAL

HUUM Drop electric heater (stones and remote control included), Narvi NM electric heater (stones included), roofing felt (underlayer): 4 rolls, SBS roofing material: 4 rolls, roofing nails, EPDM, rain gutters, additional window. See Optional Products p. 324-345 for details.

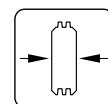

44 mm

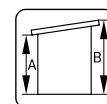

A: 211 cm
B: 239 cm

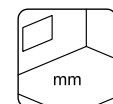

Included
28 mm

A HEATER IS THE HEART OF YOUR SAUNA

A heater is like the heart of a sauna, without the heater there will be undoubtedly no joy of being in a sauna. Although both wood-burning and electric heaters have their advantages and drawbacks, eventually, the choice of the heater is a matter of personal preference. Our saunas are developed for heating with electric heaters, which we offer as optional products. Electric heaters heat up the sauna fast, allow the users to have control over the temperature and change it easily. Please keep in mind to use a licensed electrician to complete the installation of an electric heater.

There are two heaters in our selection – HUUM Drop and Narvi NM, both 6 kW. Please get familiar with the descriptions and specifications so you can make the right decision for choosing the one for your sauna. For further information please ask from the salesteam.

Narvi NM electrical heater 6 kW

Black painted, stainless steel

2-year warranty

Measures: 580 x 430 x 300 mm (height x width x depth)

Safety distance: sides 50 mm, front 80 mm, up 1150 mm, floor 120 mm

The set includes

- electric sauna heater
- sauna stones (two boxes, 40 kg)
- installation brackets and connection wiring (different wires inside the heater)

The wire from heater to plug is not included in the set. The heater has the readiness for this cable – the holes in the heater where to put the wire ends from the plug.



Power

Fuse	3 x 10 A
Supply voltage 3-phase	400 V 3N
Cable	5 x 1,5 (N x mm ²)

In the case of a 230 1N connection, an analogous connection is made to the 3-phase. The heating circuits must be done before the circuit breaker.

All of the electrical connections must be done by a certified professional.



HUUM Drop electrical heater 6 kW

Stainless steel

5-year warranty

Measures: 590 x 390 x 335 mm (height x width x depth)

Safety distance: sides and front 120 mm

The set includes

- electric sauna heater
- sauna stones (four boxes, 60 kg)
- built-in electronic control (UKU Local controller)
- wall mount
- 5+5 m cable for temperature and door sensor
- 3 m cable for main module and user interface
- Screws for fastening the user interface and temperature sensor



Power

Fuse	3 x 10 A
Supply voltage 3-phase	400 V 3N
Cable	5 x 1,5 (N x mm ²)

In the case of a 230 1N connection, an analogous connection is made to the 3-phase. The heating circuits must be done before the circuit breaker.

All of the electrical connections must be done by a certified professional.



UKU Local controller

Temperatures: 40-110°C

Supply voltage: 400 V 3N; 230 V 1N

Heating period: 3h, 8h, 12h

Connectable to lights/ventilation and steamer

Temperature sensor and overheating protection

Door sensor

Child safety lock

Timer

The set includes

Control console (105 x 55 x 22 mm)

Control console cable (3 m; 4 x 0,34 mm²)

Main module (142 x 90 x 58 mm)

Temperature sensor

Door sensor

Temperature/door sensor cable (5 + 5m; 2 x 0,22 mm²)

OPTIONAL PRODUCTS

SEE OPTIONAL PRODUCTS, PAGES 324-345

Sauna	Art. No.	Roofing felt, rolls	SBS roofing material, rolls	Roofing material, Roofing nails, 1 kg	EPDM ²	Rain gutters	HUUM Drop sauna heater	Narvi NIM sauna heater	Additional door	Additional window
Anita 0,9 m ²	110543	107210, 1 rolls	107214, 1 rolls	107930						
Anita 1,3+0,7 m ²	110070	107210, 2 rolls	107214, 2 rolls	107930						
Anita 1,3+0,7 m ² with glass wall	111005	107210, 2 rolls	107214, 2 rolls	107930						
Anita 1,6+0,7 m ²	111005	107210, 2 rolls	107214, 2 rolls	107930						
Anita 1,6+0,7 m ² with glass wall	111004	107210, 2 rolls	107214, 2 rolls	107930						
Anette 3,0+1,5 m ²	110071	107210, 2 rolls	107214, 2 rolls	107930						
Sanna 4,1 m ²	110741	107210, 2 rolls	107214, 2 rolls	107930	107169	106627	110119	110115	111740	111738
Sanna 4,1+5,9 m ²	110526	107210, 4 rolls	107214, 4 rolls	107930	107172	106628	110119	110115	111740	111738
Sanna 6,8 m ²	111001	107210, 2 rolls	107214, 2 rolls	107930	107166	107375	110119	110115	111740, 111741	111738, 111739
Sanna 6,8+5,9 m ²	111002	107210, 4 rolls	107214, 4 rolls	107930	108276	106626 + 106627	110119	110115	111740, 111741	111738, 111739
Sanna 12,8 m ² Slide	111000	107210, 4 rolls	107214, 4 rolls	107930	107172	106628	110119	110115	111741	111738
Sanna 12,8 m ² Slide Plus	111239	107210, 4 rolls	107214, 4 rolls	107930	107172	106628	110119	110115	111741	111738

² Includes glue for EPDM installation. Read more about EPDM p. 331.

